



**ProLight PBVC-10FWU-F3G**  
**10W Power LED**  
**Technical Datasheet**  
**Version: 1.7**

# ProLight Opto ProEngine Series

## Features

- High flux density of lighting source
- Good color uniformity
- RoHS compliant
- More energy efficient than incandescent and most halogen lamps
- Long lifetime
- AEC-Q102 Qualified
- SAE/ECE compliant

## Main Applications

- Bicycle Lamps
- Exterior Automotive Lighting
- Floodlight

*Automotive*

## Introduction

- The input power is 10 Watt, the multi-chip ultra high power ProEngine Series delivers never before seen luminous flux output from a single emitter. The superficial illuminating nature of ProEngine makes them the preference bicycle lamps, typical applications include exterior automotive lighting and floodlight.

## Mechanical Dimensions

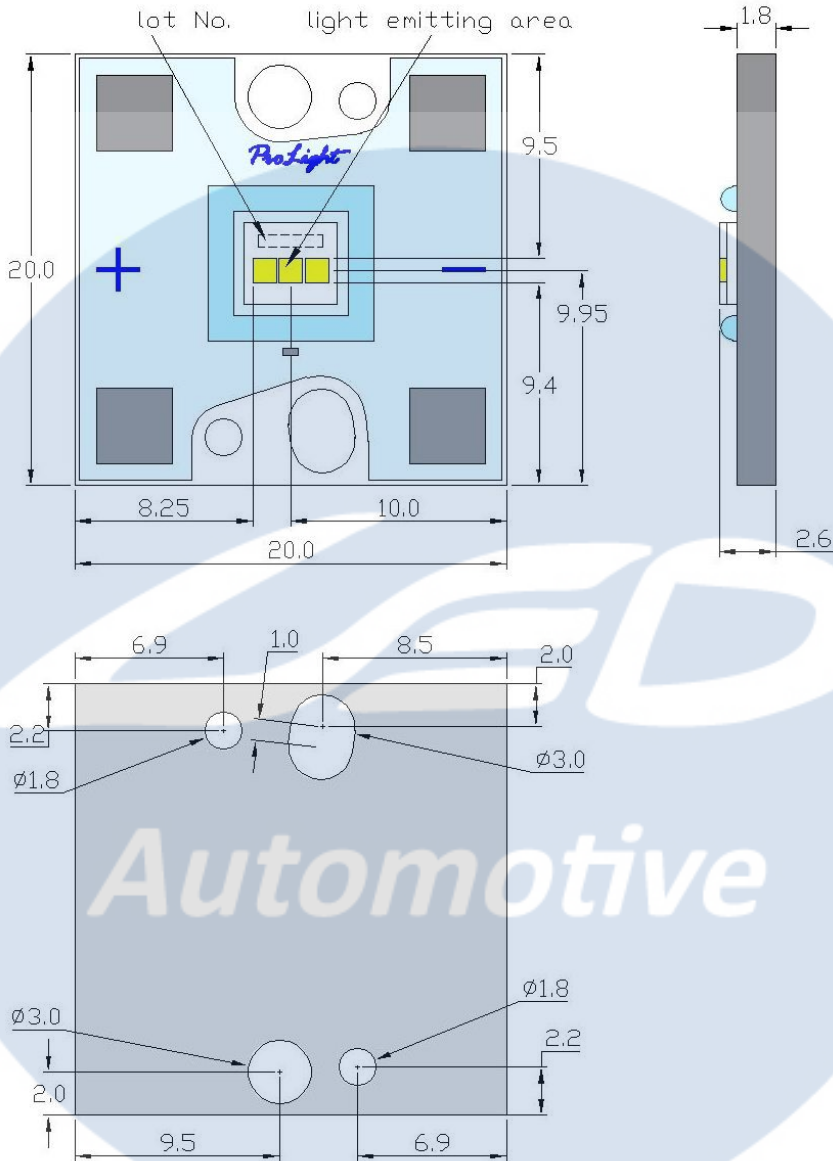

### Notes:

1. Solder pads are labeled "+" and "-" to denote positive and negative, respectively.
2. Drawing not to scale.
3. All dimensions are in millimeters.
4. Unless otherwise indicated, tolerances are  $\pm 0.3\text{mm}$ .
5. **Please do not use a force of over 0.3kgf impact or pressure on the lens of the LED, otherwise it will cause a catastrophic failure.**

\*The appearance and specifications of the product may be modified for improvement without notice.

## Flux Characteristics, $T_j = 25^\circ\text{C}$

Radiation Pattern	Color	Part Number Emitter	Luminous Flux $\Phi_v$ (lm)			
			@1000mA		Refer @1200mA	
			Minimum	Typical	Minimum	Typical
Flat	White	PBVC-10FWU-F3G	900	1100	1000	1250

- ProLight maintains a tolerance of  $\pm 7\%$  on flux and power measurements.
- Please do not drive at rated current more than 1 second without proper heat sink.

## Electrical Characteristics, $T_j = 25^\circ\text{C}$

Color	Forward Voltage $V_F$ (V)				Thermal Resistance Junction to Board ( $^\circ\text{C}/\text{W}$ )
	Min.	@1000mA Typ.	Max.	Refer @1200mA Typ.	
White	7.2	9.7	11.5	9.9	2

- ProLight maintains a tolerance of  $\pm 0.1\text{V}$  for Voltage measurements.

## Optical Characteristics at 1000mA, $T_j = 25^\circ\text{C}$

Radiation Pattern	Color	Color Temperature CCT			Total included Angle (degrees) $\theta_{0.90v}$	Viewing Angle (degrees) $2\theta_{1/2}$
		Min.	Typ.	Max.		
Flat	White	5380 K	5620 K	5860 K	160	120
		5620 K	5880 K	6140 K	160	120
		5870 K	6150 K	6430 K	160	120
		6140 K	6450 K	6760 K	160	120

- ProLight maintains a tolerance of  $\pm 5\%$  for CCT measurements.

## Absolute Maximum Ratings

Parameter	White
Max DC Forward Current (mA)	1500
Peak Pulsed Forward Current (mA)	1500 (less than 1/10 duty cycle@1KHz)
LED Junction Temperature	150°C
Junction Temperature for short time applications*	175°C
Operating Board Temperature at Maximum DC Forward Current	-40°C - 125°C
Storage Temperature	-40°C - 100°C
Reverse Voltage	Not designed to be driven in reverse bias
ESD withstand voltage(kV) (acc. to IEC 61000-4-2-air discharge)	up to 8

Note: \* The LED chip exhibits excellent performance but slight package discoloration occurs at highest temperatures. Exemplary median lifetime for  $T_J = 175^\circ\text{C}$  is 100h.



# Color Bin

## White Binning Structure Graphical Representation

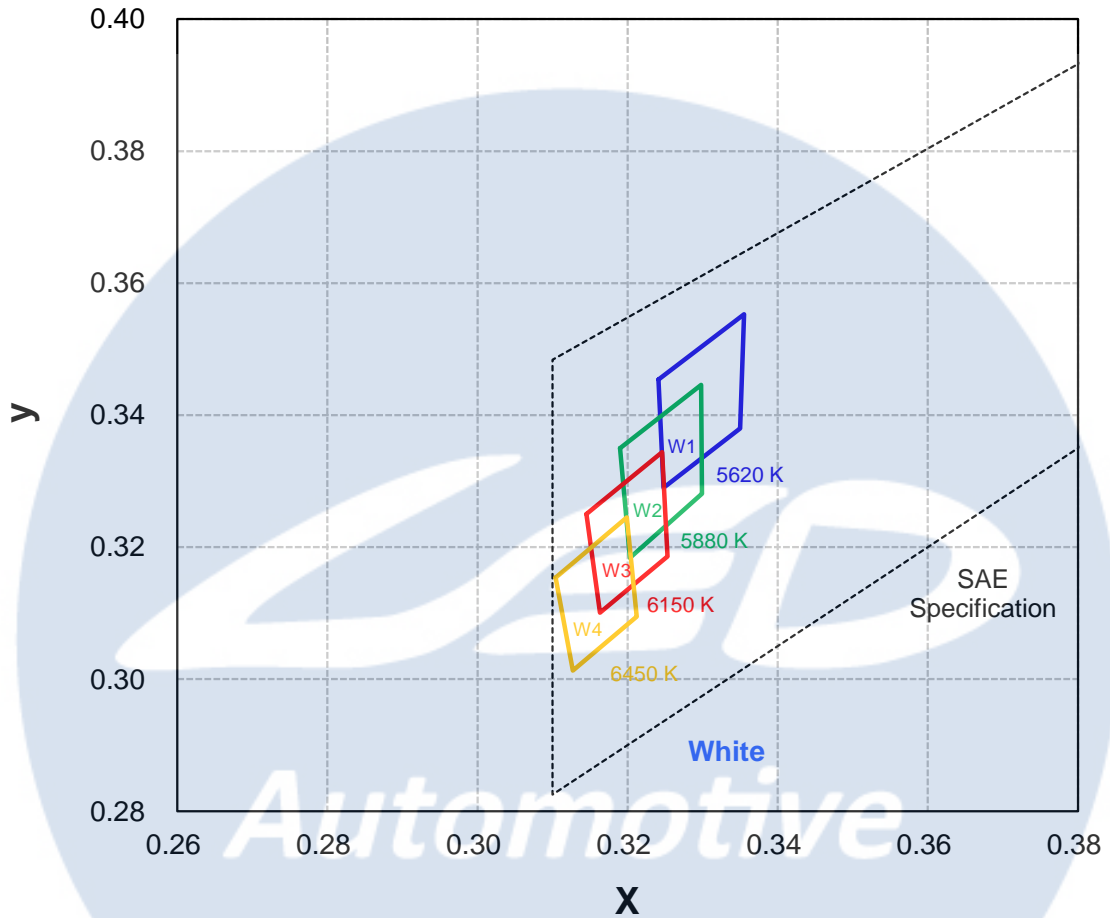

White Bin Structure

Bin Code	x	y	Typ. CCT (K)	Bin Code	x	y	Typ. CCT (K)
W1	0.3241	0.3454	5620	W3	0.3145	0.3250	6150
	0.3248	0.3290			0.3163	0.3101	
	0.3350	0.3380			0.3253	0.3186	
	0.3355	0.3553			0.3246	0.3344	
W2	0.3190	0.3350	5880	W4	0.3104	0.3154	6450
	0.3203	0.3184			0.3127	0.3013	
	0.3299	0.3281			0.3212	0.3095	
	0.3298	0.3446			0.3199	0.3245	

- Tolerance on each color bin (x, y) is  $\pm 0.005$

## Color Spectrum, $T_c = 25^\circ\text{C}$

### 1. White

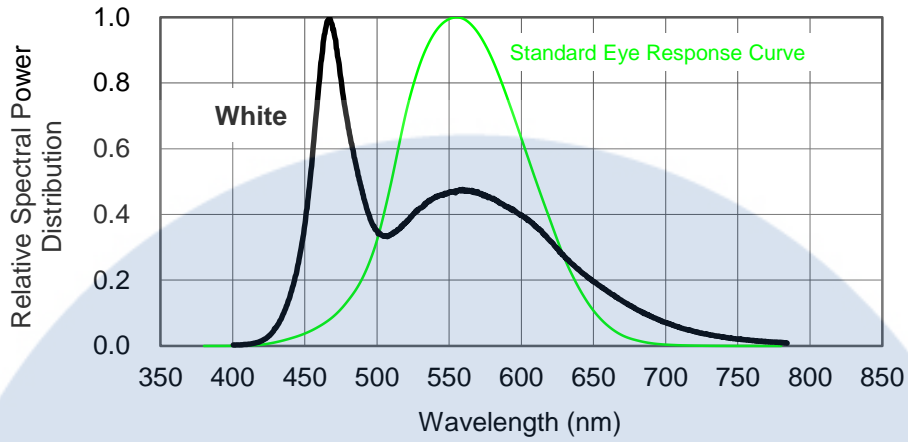

Note: Percentage of UV:  $<10^{-5}\text{W/lm}$  acc. to ECE regulation.

**LED**  
*Automotive*

## Junction Temperature Relative Characteristics

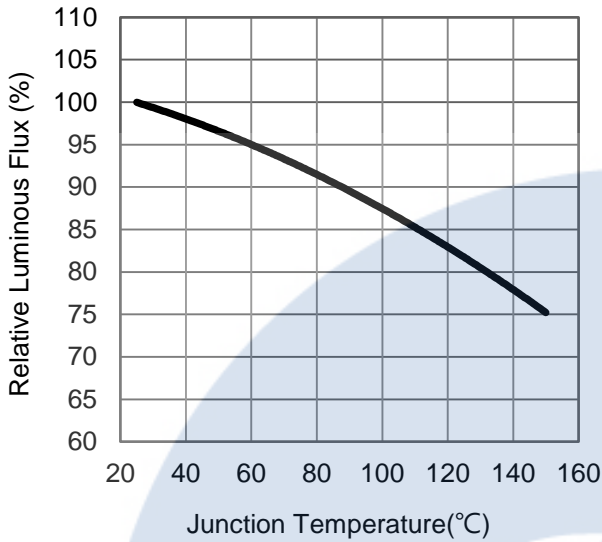

Fig 1. Junction Temperature vs. Relative Luminous Flux at 1000mA.

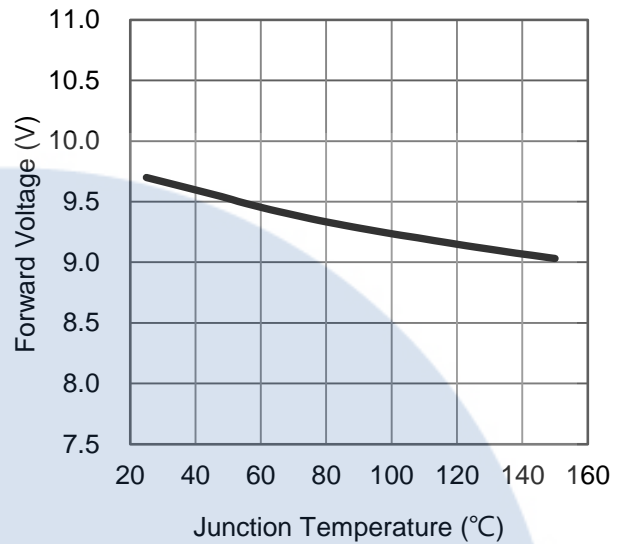

Fig 2. Junction Temperature vs. Forward Voltage at 1000mA.

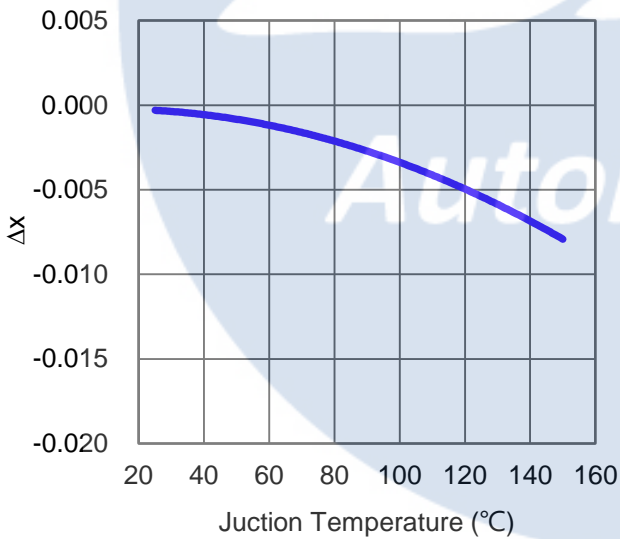

Fig 3. Junction Temperature vs. Chromaticity Coordinate  $\Delta x$  at 1000mA.

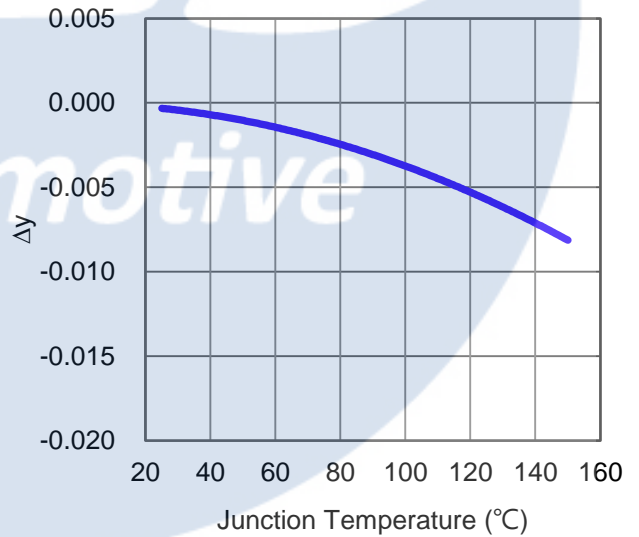

Fig 4. Junction Temperature vs. Chromaticity Coordinate  $\Delta y$  at 1000mA.

## Forward Current Relative Characteristics

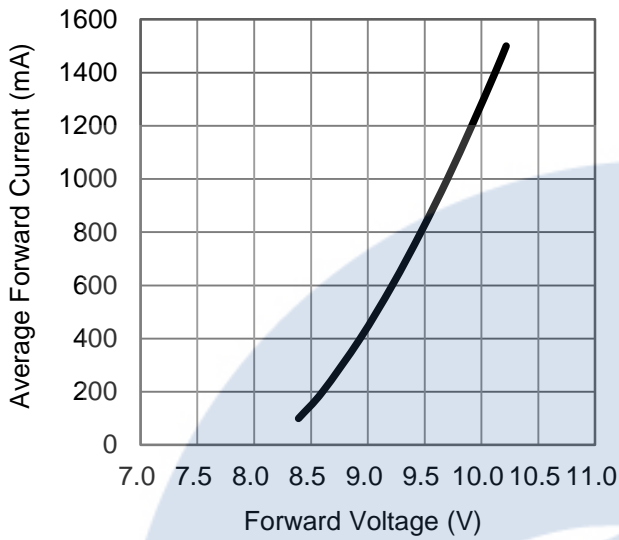

Fig 5. Forward Voltage vs. Forward Current at  $T_j=25^\circ\text{C}$ .

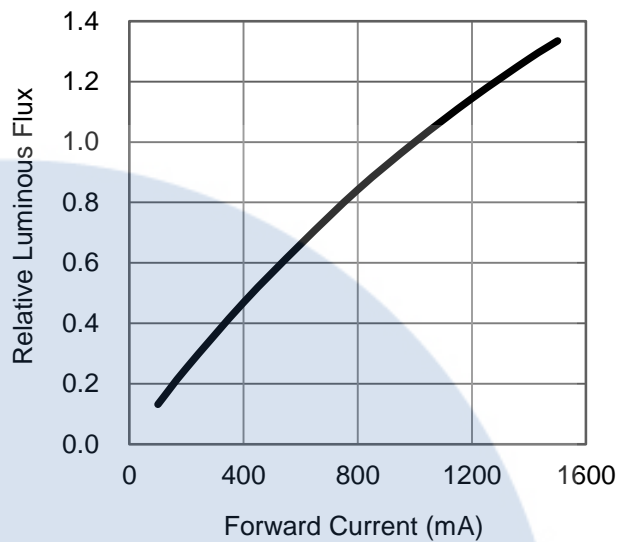

Fig 6. Forward Current vs. Relative Luminous Flux at  $T_j=25^\circ\text{C}$ .

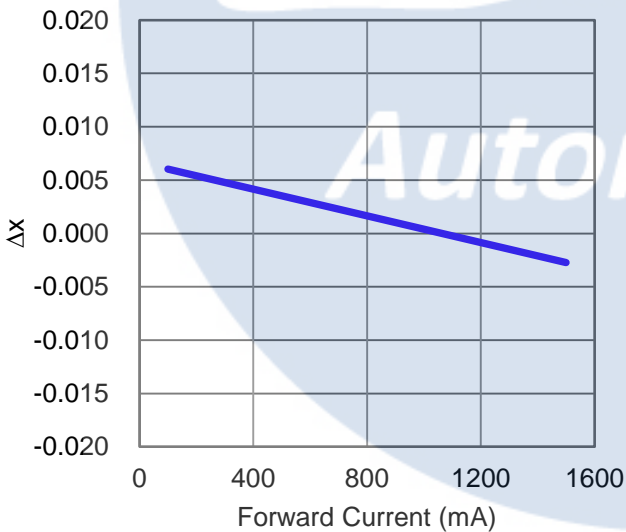

Fig 7. Forward Current vs. Chromaticity Coordinate  $\Delta x$  at  $T_j=25^\circ\text{C}$ .

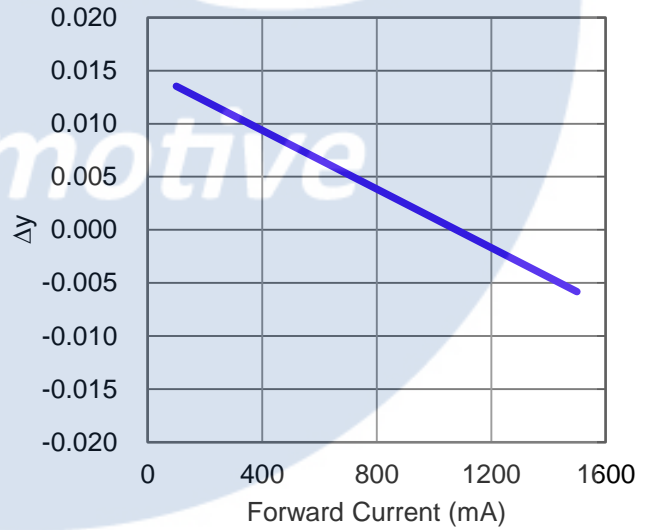
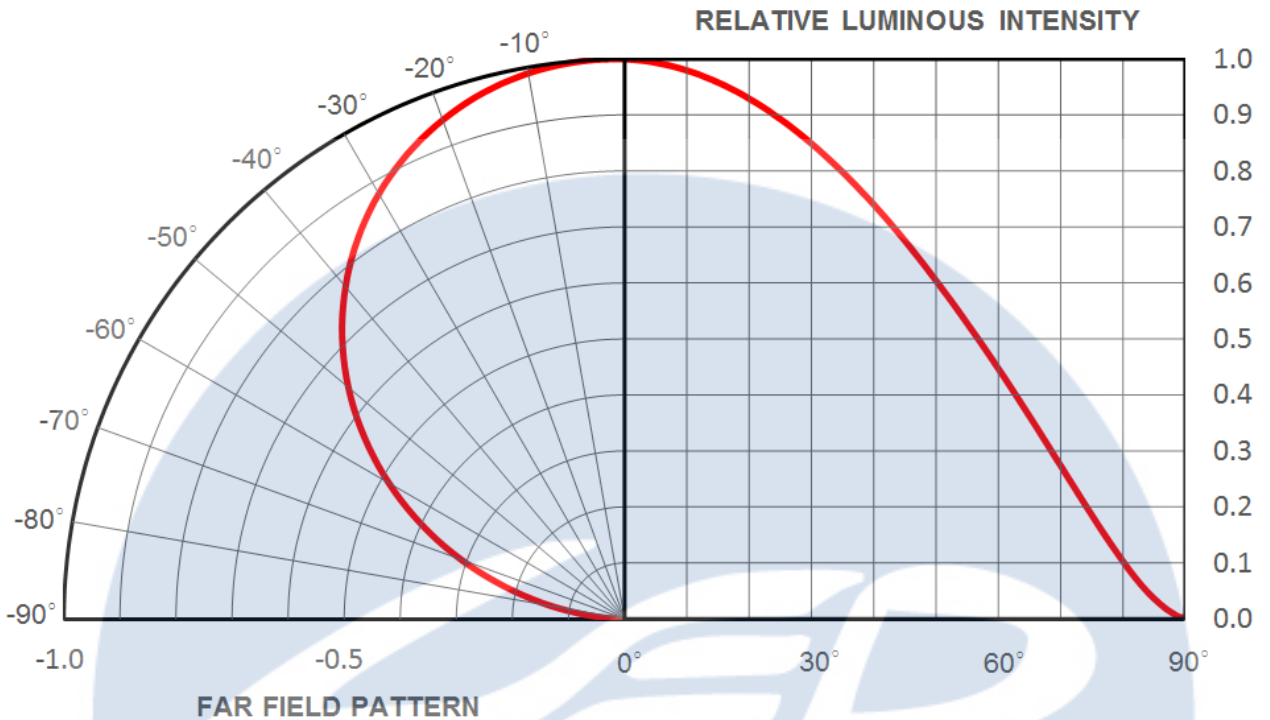

Fig 8. Forward Current vs. Chromaticity Coordinate  $\Delta y$  at  $T_j=25^\circ\text{C}$ .



## Typical Representative Spatial Radiation Pattern



## Moisture Sensitivity Level – JEDEC Level 1

Level	Floor Life		Soak Requirements			
			Standard		Accelerated Environment	
	Time	Conditions	Time (hours)	Conditions	Time (hours)	Conditions
1	Unlimited	≤30°C / 85% RH	168 +5/-0	85°C / 85% RH	NA	NA

- The standard soak time includes a default value of 24 hours for semiconductor manufacture's exposure time (MET) between bake and bag and includes the maximum time allowed out of the bag at the distributor's facility.
- Table below presents the moisture sensitivity level definitions per IPC/JEDEC's J-STD-020C.

Level	Floor Life		Soak Requirements			
			Standard		Accelerated Environment	
	Time	Conditions	Time (hours)	Conditions	Time (hours)	Conditions
1	Unlimited	≤30°C / 85% RH	168 +5/-0	85°C / 85% RH	NA	NA
2	1 year	≤30°C / 60% RH	168 +5/-0	85°C / 60% RH	NA	NA
2a	4 weeks	≤30°C / 60% RH	696 +5/-0	30°C / 60% RH	120 +1/-0	60°C / 60% RH
3	168 hours	≤30°C / 60% RH	192 +5/-0	30°C / 60% RH	40 +1/-0	60°C / 60% RH
4	72 hours	≤30°C / 60% RH	96 +2/-0	30°C / 60% RH	20 +0.5/-0	60°C / 60% RH
5	48 hours	≤30°C / 60% RH	72 +2/-0	30°C / 60% RH	15 +0.5/-0	60°C / 60% RH
5a	24 hours	≤30°C / 60% RH	48 +2/-0	30°C / 60% RH	10 +0.5/-0	60°C / 60% RH
6	Time on Label (TOL)	≤30°C / 60% RH	Time on Label (TOL)	30°C / 60% RH	NA	NA

## Reliability testing in accordance with AEC-Q102

The development of this product included extensive operational life-time testing and environmental testing. Table 1 summarizes the tests applied and cumulative test results obtained from testing performed in accordance with AEC-Q102.

**Table 1. Operating life, mechanical and environmental tests performed on it's package in accordance with AEC-Q102.**

Abrb Stress	Conditions	Duration	Failure Criteria	Rejects
<b>TEST</b> Pre- and Post-Stress Electrical Test	$T_J = 25^\circ\text{C}$	N/A	See notes [2]	0
<b>PC</b> Pre-conditioning	JESD22-A113 Soak $T_{amb} = 85^\circ\text{C}$ , RH = 85% Reflow soldering	168 hours 3 cycles	See notes [2]	0
<b>EV</b> External Visual	JESD22 B-101	N/A	See notes [2]	0
<b>HTFB</b> High Temperature Forward Bias	JESD22-A108 $T_{amb} = 85^\circ\text{C}$ , IF = max. DC [1]	1000 hours	See notes [2]	0
<b>TC</b> Temperature Cycling	JESD22-A104 $-30^\circ\text{C}$ to $80^\circ\text{C}$	1000 cycles	See notes [2]	0
<b>HTHHB</b> High temp. & High Humidity Bias	JESD22-A101 $T_{amb} = 85^\circ\text{C}$ , RH = 85%, IF = max. DC [1]	1000 hours	See notes [2]	0
<b>PTC</b> Power and Temperature cycle	$-30^\circ\text{C}$ to $85^\circ\text{C}$ , 10 minutes dwell, 20 minutes transfer (1 hour cycle), 2 minutes ON/2 minutes OFF, IF = max. DC [1]	1000 hours	See notes [2]	0
<b>ESD</b>	AEC Q101-001	8000V	See notes [2]	0
<b>VVF</b> Vibration Variable Frequency	10-2000-10 Hz, log or linear sweep rate, 20 G about 1 min., 1.5 mm, 3X/axis	--	See notes [3]	0
<b>MS</b> Mechanical Shock	1500 G, 0.5 msec. pulse, 5 shocks each 6 axis	--	See notes [3]	0
<b>RSH</b> Resistance to Solder Heat	JESD22-A111 / JESD22-B106 $260^\circ\text{C} \pm 5^\circ\text{C}$	10 s	See notes [3]	0
<b>SD</b> Solderability	J-STD-002 $245^\circ\text{C} \pm 5^\circ\text{C}$	3 s	See notes [3]	0

Notes:

- Depending on the maximum derating curve.
- Criteria for judging failure

Item	Test Condition	Criteria for Judgement	
		Min.	Max.
Forward Voltage ( $V_F$ )	$I_F = \text{max DC}$	--	Initial Level x 1.1
Luminous Flux or Radiometric Power ( $\Phi_V$ )	$I_F = \text{max DC}$	Initial Level x 0.8	--
Reverse Current ( $I_R$ )	$V_R = 5\text{V}$	--	50 $\mu\text{A}$

\* The test is performed after the LED is cooled down to the room temperature.

- A failure is an LED that is open or shorted.

## Packing Specifications



### Notes:

1. 20 pieces per tube.
2. Drawing not to scale.
3. All dimensions are millimeters.
4. All dimensions without tolerances are for reference only.

\*\* Please do not open the moisture barrier bag (MBB) more than one week. This may cause the leads of LED discoloration. We recommend storing ProLight's LEDs in a dry box after opening the MBB. The recommended storage conditions are temperature 5 to 30°C and humidity less than 40% RH.

## Recommended Soldering Condition

- Please use lead free and “no clean ” solders.
- Soldering shall be implemented using a soldering tip at a temperature lower than 350 °C, and shall be finished within 3.5 seconds for each pad.
- During the soldering process, put the LEDs on materials whose conductivity is poor enough not to radiate heat of soldering.
- Properly solder tin wires before soldering them to LEDs.
- Avoid touching the glass lens with the soldering iron.
- Please prevent flux from touching to the glass lens.
- Please solder evenly on each pad.
- Contacts number of a soldering tip should be within twice for each pad.
- Next process of soldering should be carried out after the LEDs have return to ambient temperature.

\*ProLight cannot guarantee if usage exceeds these recommended conditions.

Please use it after sufficient verification is carried out on your own risk if absolutely necessary.

## Precaution for Use

- The modules light output are intense enough to cause injury to human eyes if viewed directly. Precautions must be taken to avoid looking directly at the modules with unprotected eyes.
- The modules are sensitive to electrostatic discharge. Appropriate ESD protection measures must be taken when working with the modules. Non-compliance with ESD protection measures may lead to damage or destruction of the product.
- Chemical solvents or cleaning agents must not be used to clean the modules. Mechanical stress on the Emitters must be avoided. It is best to use a soft brush, damp cloth or low-pressure compressed air.
- The products should be stored away from direct light in dry location.
- The appearance, specifications and flux bin of the product may be modified for improvement without notice. Please refer to the below website for the latest datasheets.  
<http://www.prolightopto.com/>

## Handling of without Cover Lens LEDs

Notes for handling of without cover lens LEDs

- Please do not use a force of over 0.3kgf impact or pressure on the emitting area, otherwise it will cause a catastrophic failure.
- Avoid touching the emitting area especially by sharp tools such as Tweezers.
- Avoid leaving fingerprints on the emitting area .
- Please store the LEDs away from dusty areas or seal the product against dust.
- Please do not mold over the emitting area with another resin. (epoxy, urethane, etc)

