

ProLight PB2D-1JLA-TC
1W UV Power LED
Technical Datasheet
Version: 1.6

ProLight Opto [®] PB2D Series

Features

- Best thermal material solution of the world
- RoHS compliant
- View angle 30°

Main Applications

- Disinfection
- Phototherapy
- Bio-Analysis/Detection

Emitter Mechanical Dimensions

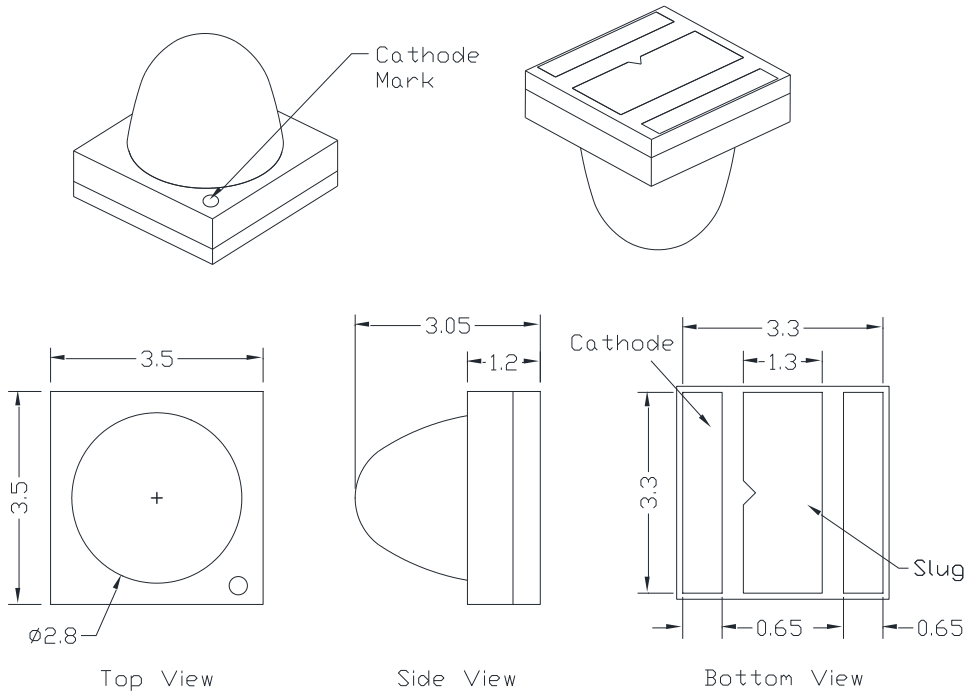

Circuit Diagram

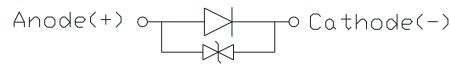

Notes:

1. The cathode side of the device is denoted by the chamfer on the part body.
2. Electrical insulation between the case and the board is required. Do not electrically connect either the anode or cathode to the slug.
3. Drawing not to scale.
4. All dimensions are in millimeters.
5. Unless otherwise indicated, tolerances are ± 0.10 mm.
6. Please do not solder the emitter by manual hand soldering, otherwise it will damage the emitter.
7. **Please do not use a force of over 3kgf impact or pressure on the lens of the LED, otherwise it will cause a catastrophic failure.**

*The appearance and specifications of the product may be modified for improvement without notice.

Flux Characteristics at 100mA, T_j = 25°C

Radiation Pattern	Color	Part Number Emitter	Radiometric Power (mW)	
			Minimum	Typical
Lambertian	UVC	PB2D-1JLA-TC	8.5	10

- ProLight maintains a tolerance of $\pm 10\%$ on flux and power measurements.
- Please do not drive at rated current more than 1 second without proper heat sink.

Electrical Characteristics at 100mA, T_j = 25°C

Color	Forward Voltage V _F (V)			Thermal Resistance Junction to Slug (°C/W)
	Min.	Typ.	Max.	
UVC	5.0	6.8	8.0	15

- ProLight maintains a tolerance of $\pm 0.1V$ for Voltage measurements.

Optical Characteristics at 100mA, T_j = 25°C

Radiation Pattern	Color	Peak Wavelength λ_P			Total included Angle (degrees) $\theta_{0.90V}$	Viewing Angle (degrees) $2\theta_{1/2}$
		Min.	Typ.	Max.		
Lambertian	UVC	265 nm	275 nm	280 nm	60	30

- ProLight maintains a tolerance of $\pm 3nm$ for dominant wavelength measurements.

Absolute Maximum Ratings

Parameter	UVC
DC Forward Current (mA)	150
ESD Sensitivity (HBM per MIL-STD-883E Method 3015.7)	±4000V
LED Junction Temperature	85°C
Operating Board Temperature at Maximum DC Forward Current	-40°C - 60°C
Storage Temperature	-40°C - 85°C
Soldering Temperature	JEDEC-J-STD-020D
Allowable Reflow Cycles	3
Reverse Voltage	Not designed to be driven in reverse bias

Peak Wavelength Bin Structure

Color	Bin Code	Minimum Peak Wavelength (nm)	Maximum Peak Wavelength (nm)
UVC	A	265	270
	B	270	275
	C	275	280

- ProLight maintains a tolerance of $\pm 3\text{nm}$ for peak wavelength measurements.

Forward Voltage Bin Structure

Color	Bin Code	Minimum Voltage (V)	Maximum Voltage (V)
UVC	A	5.0	5.5
	B	5.5	6.0
	C	6.0	6.5
	D	6.5	7.0
	E	7.0	7.5
	F	7.5	8.0

- ProLight maintains a tolerance of $\pm 0.1\text{V}$ for Voltage measurements.

Note: Although several bins are outlined, product availability in a particular bin varies by production run and by product performance. Not all bins are available in all colors.

Color Spectrum, $T_j = 25^\circ\text{C}$

1.UVC

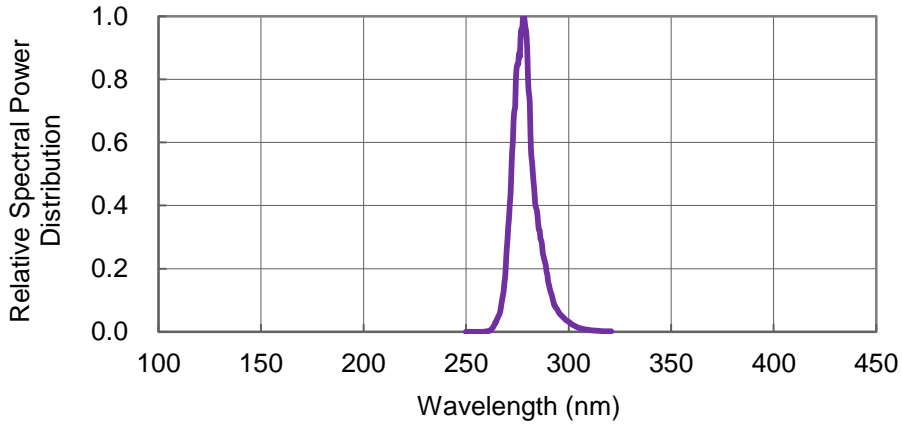

Forward Current Characteristics, $T_j = 25^\circ\text{C}$

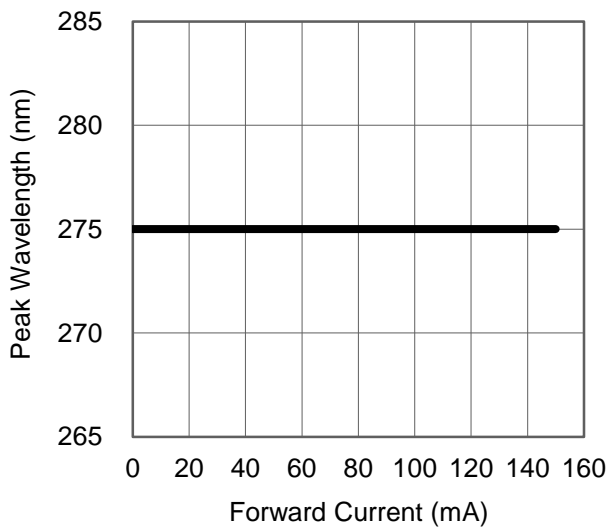

Fig 1. Forward Current vs. Peak Wavelength

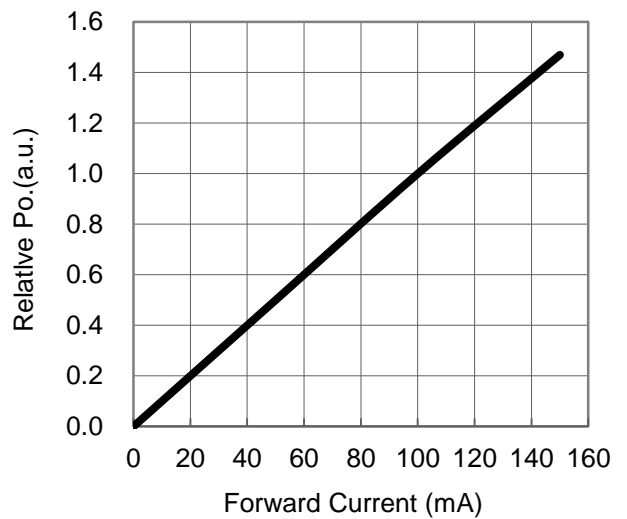

Fig 2. Forward Current vs. Relative Radiant Flux

Forward Current Characteristics, $T_j = 25^\circ\text{C}$

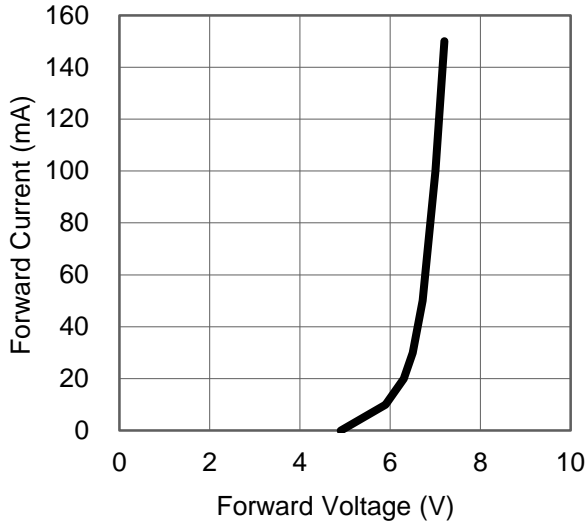

Fig 3. Forward Voltage vs Forward Current

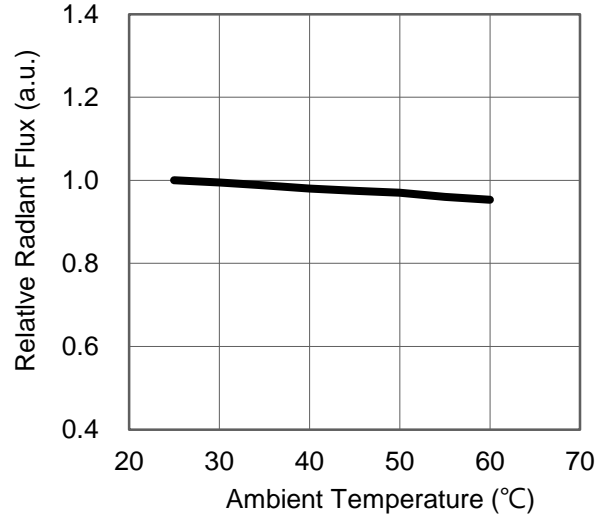

Fig 4. Ambient Temperature vs. Relative Radiant Flux

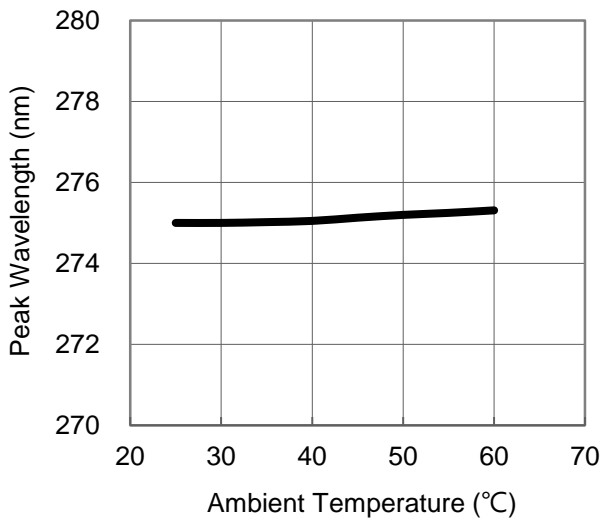

Fig 5. Ambient Temperature vs. Peak Wavelength

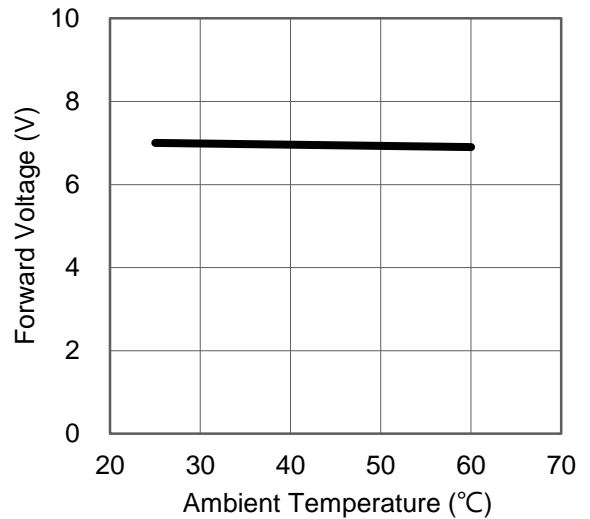
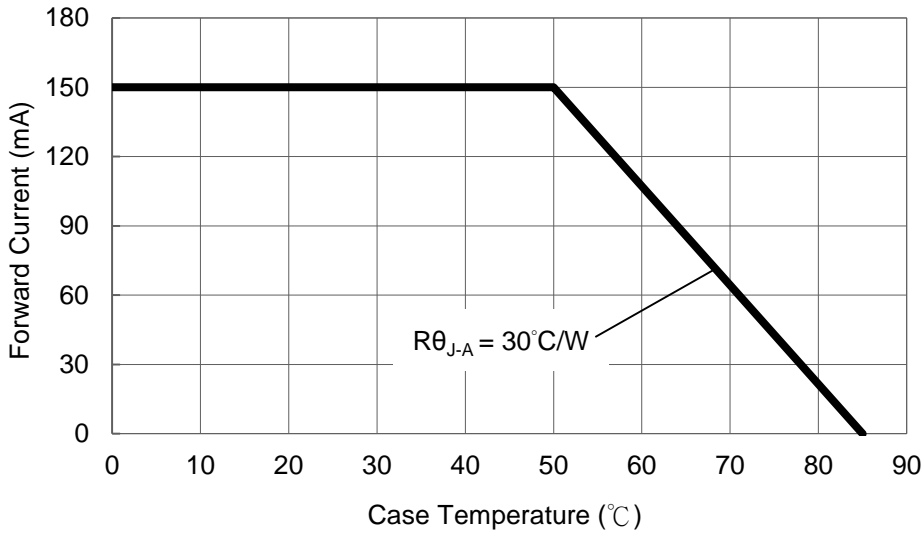

Fig 6. Ambient Temperature vs. Forward Voltage

Case Temperature vs. Maximum Forward Current

1. UVC ($T_{JMAX} = 85^{\circ}C$)



Typical Representative Spatial Radiation Pattern

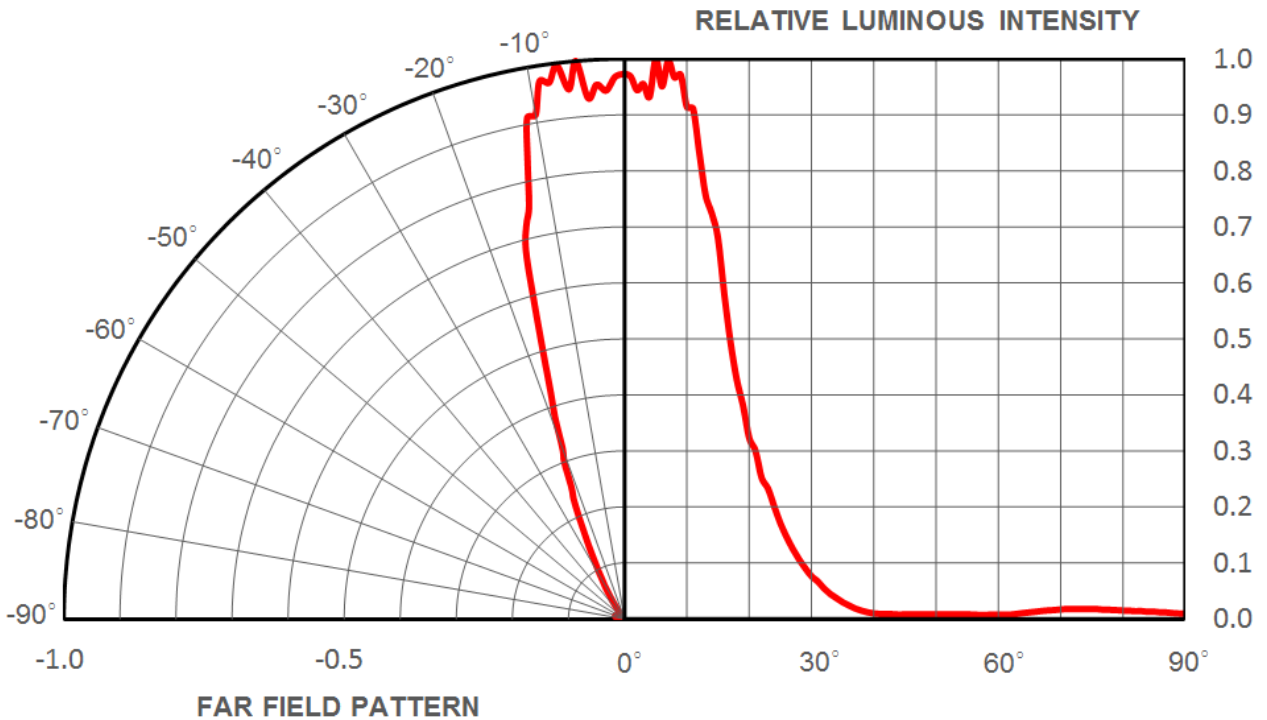

During Storage

Conditions		Temperature	Humidity	Time
Storage	Before Opening Aluminum Bag	5°C ~ 30°C	< 50%RH	Within 1 Year from the Delivery Date
	After Opening Aluminum Bag	5°C ~ 30°C	< 60%RH	≤ 672 hours
Baking		65 ± 5°C	< 10%RH	10 ~ 24 hours

- The standard soak time includes a default value of 24 hours for semiconductor manufacture's exposure time (MET) between bake and bag and includes the maximum time allowed out of the bag at the distributor's facility.
- Table below presents the moisture sensitivity level definitions per IPC/JEDEC's J-STD-020D.

Recommended Solder Pad Design

Standard Emitter

TYPE A.

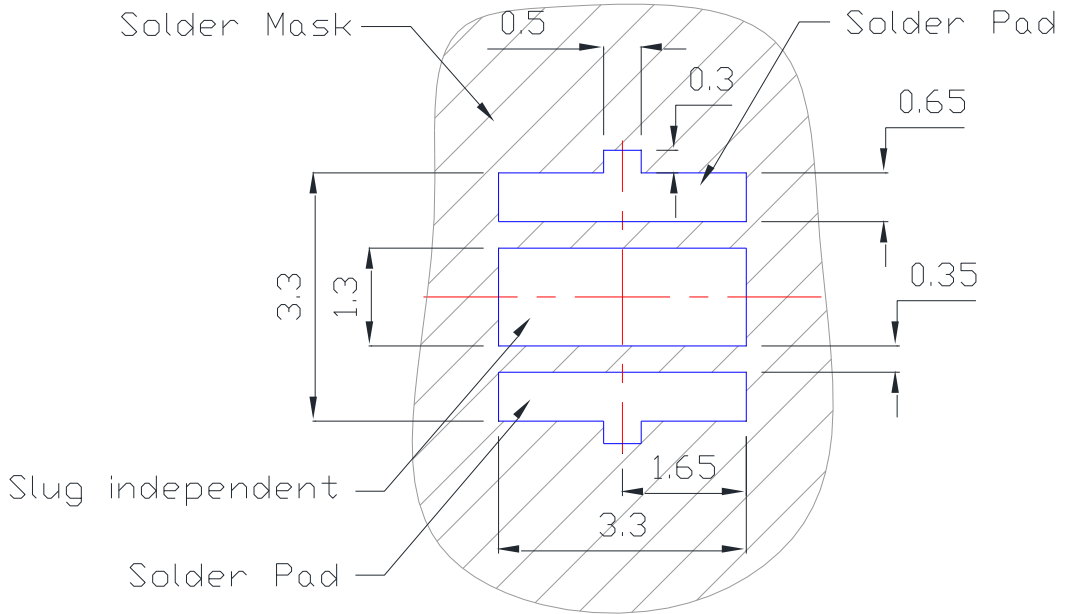

TYPE B.

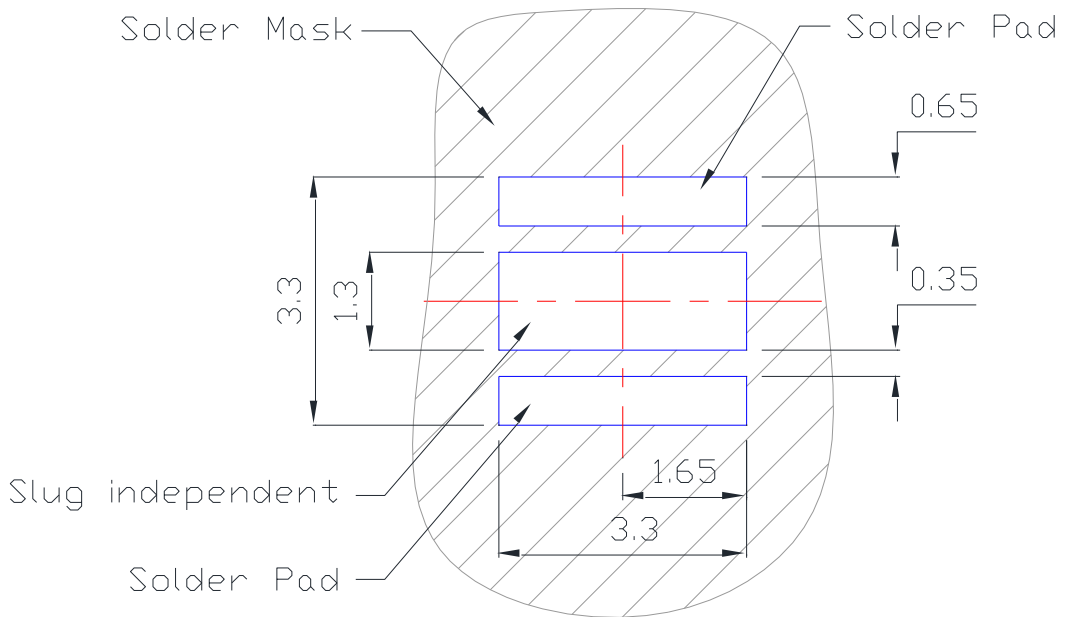

- All dimensions are in millimeters.
- Electrical isolation is required between Slug and Solder Pad.

Reflow Soldering Condition

Profile Feature	Sn-Pb Eutectic Assembly	Pb-Free Assembly
Average Ramp-Up Rate (T_{Smax} to T_p)	3°C / second max.	3°C / second max.
Preheat <ul style="list-style-type: none"> - Temperature Min (T_{Smin}) - Temperature Max (T_{Smax}) - Time (t_{Smin} to t_{Smax}) 	100°C 150°C 60-120 seconds	150°C 200°C 60-120 seconds
Time maintained above: <ul style="list-style-type: none"> - Temperature (T_L) - Time (t_L) 	183°C 60-150 seconds	217°C 60-150 seconds
Peak/Classification Temperature (T_p)	235°C	250°C
Time Within 5°C of Actual Peak Temperature (t_p)	10-20 seconds	20-30 seconds
Ramp-Down Rate	6°C/second max.	6°C/second max.
Time 25°C to Peak Temperature	6 minutes max.	8 minutes max.

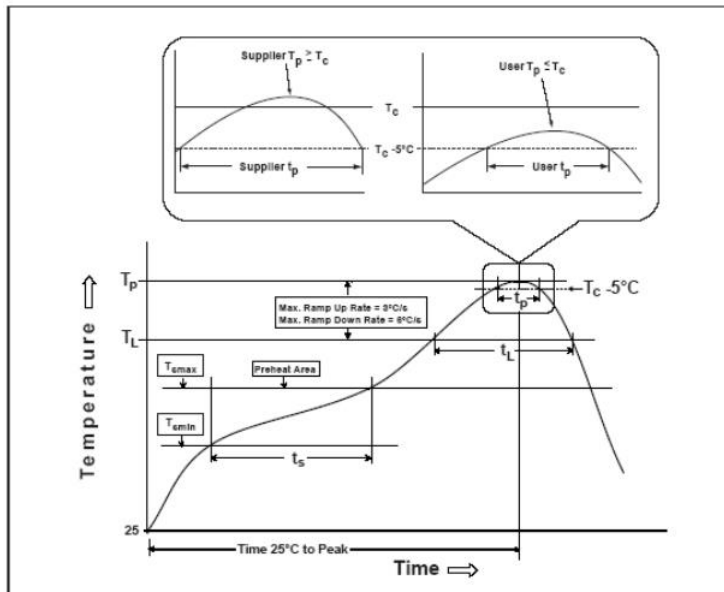

- **We recommend using the M705-S101-S4 solder paste from SMIC (Senju Metal Industry Co., Ltd.) for lead-free soldering.**
- **Do not use solder pastes with post reflow flux residue > 47%. (58Bi-42Sn eutectic alloy, etc) This kind of solder pastes may cause a reliability problem to LED.**
- All temperatures refer to topside of the package, measured on the package body surface.
- Repairing should not be done after the LEDs have been soldered. When repairing is unavoidable, a double-head soldering iron should be used. It should be confirmed beforehand whether the characteristics of the LEDs will or will not be damaged by repairing.
- Reflow soldering should not be done more than three times.
- When soldering, do not put stress on the LEDs during heating.
- After soldering, do not warp the circuit board.

Emitter Reel Packaging

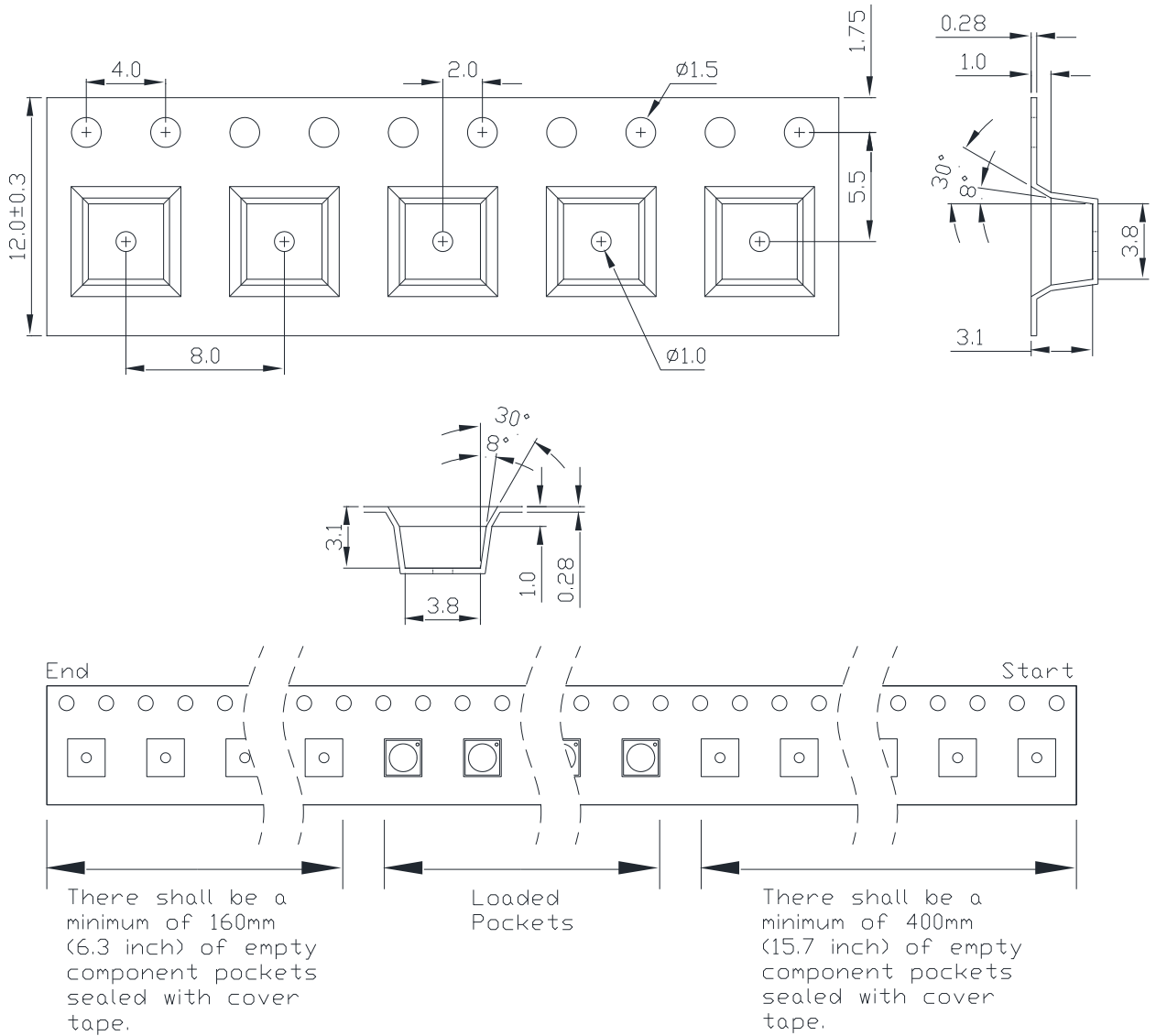

Notes:

1. Drawing not to scale.
2. All dimensions are in millimeters.
3. Unless otherwise indicated, tolerances are $\pm 0.10\text{mm}$.

Emitter Reel Packaging

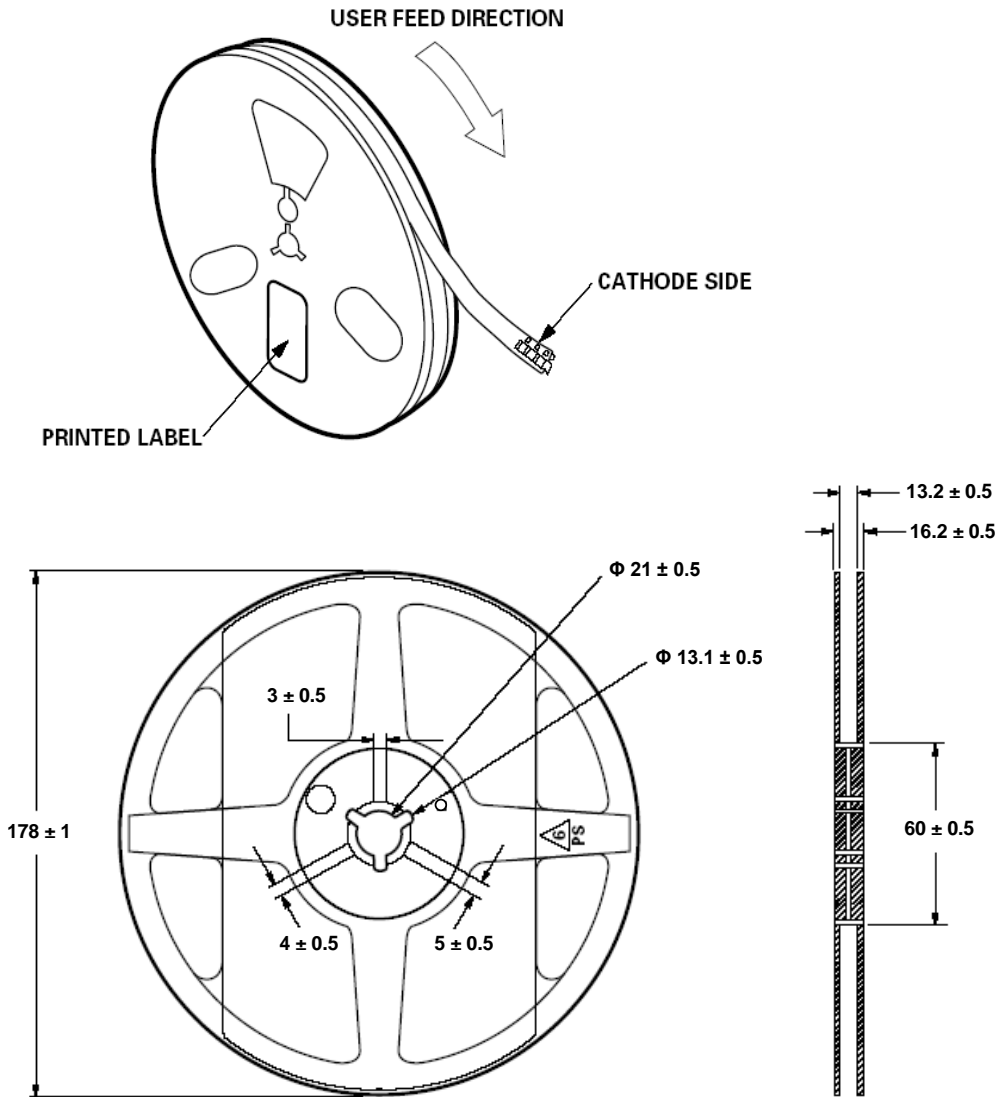

Notes:

1. Empty component pockets sealed with top cover tape.
2. 250 or 500 pieces per reel.
3. Drawing not to scale.
4. All dimensions are in millimeters.

Precaution for Use

- Storage
Please do not open the moisture barrier bag (MBB) more than one week. This may cause the leads of LED discoloration. We recommend storing ProLight's LEDs in a dry box after opening the MBB. The recommended storage conditions are temperature 5 to 30 °C and humidity less than 40% RH. It is also recommended to return the LEDs to the MBB and to reseal the MBB.
- LEDs are ESD (electrostatic discharge) sensitive; static electricity and surge voltages seriously damage UV LEDs and can result in product failure
 - (1) Ensure that tools, jigs and machines being used are properly grounded
 - (2) LED mounting equipment should include protection against voltage surge
 - (3) Use proper ESD protection, including grounded wrist straps, ESD footwear and clothes
- **We recommend using the M705-S101-S4 solder paste from SMIC (Senju Metal Industry Co., Ltd.) for lead-free soldering.**
- **Do not use solder pastes with post reflow flux residue>47%. (58Bi-42Sn eutectic alloy, etc) This kind of solder pastes may cause a reliability problem to LED.**
- Different products have different forward voltage and radiant power. In the circuit design, the distribution of current and voltage should be considered to avoid exceeding the maximum rated parameters of this product. In order to ensure the best use, it is recommended to assign a resistor in series to each emitter in the matrix circuit.

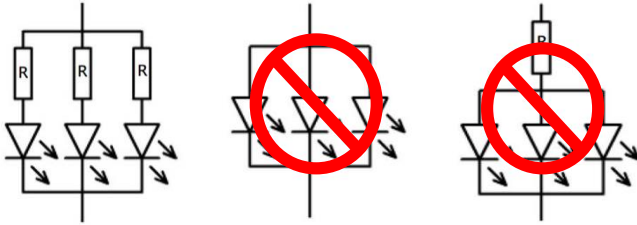

- Any mechanical force or any excess vibration shall not be accepted to apply during cooling process to normal temperature after soldering.
- Please avoid rapid cooling after soldering.
- Components should not be mounted on warped direction of PCB.
- Repairing should not be done after the LEDs have been soldered. When repairing is unavoidable, a heat plate should be used. It should be confirmed beforehand whether the characteristics of the LEDs will or will not be damaged by repairing.
- This device should not be used in any type of fluid such as water, oil, organic solvent and etc. When cleaning is required, isopropyl alcohol should be used.
- When the LEDs are illuminating, operating current should be decided after considering the package maximum temperature.
- The appearance, specifications and flux bin of the product may be modified for improvement without notice. Please refer to the below website for the latest datasheets.
<http://www.prolightopto.com/>

Recommend Drive Circuit

- Using a parallel circuit design will provide a different forward current for each LED, which means that the LED shows unexpected output performance. In the worst case, the current may exceed the absolute maximum rating that stresses the LED. In order to avoid this situation, we strongly recommend the application of current-limiting resistors in each series drive circuit.
- Reverse voltage will damage the Zener diode and LEDs.

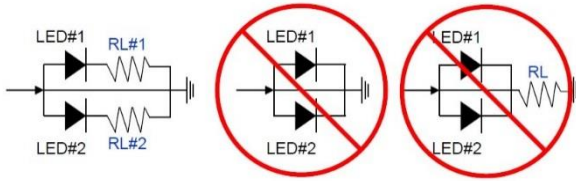

Eye Safety Guidelines

- During operation, the LED emits high intensity ultraviolet (UV) light, which is harmful to skin and eyes. UV light is hazardous to skin and may cause cancer. Avoid exposure to UV light when LED is operational. Precautions must be taken to avoid looking directly at the UV light without the use of UV light protective glasses. Do not look directly at the front of the LED or at the LED's lens when LED is operational.
- Attach warning labels on products/systems that use UV LEDs.

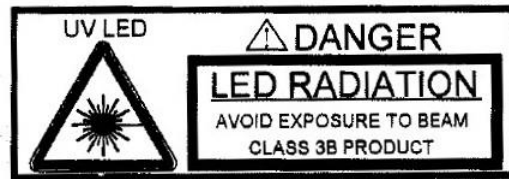

Use Handling of Quartz Lens LEDs

Notes for handling of quartz lens LEDs

- Please do not use a force of over 3kgf impact or pressure on the quartz lens, otherwise it will cause a catastrophic failure.
- The LEDs should only be picked up by making contact with the sides of the LED body.
- Avoid touching the quartz lens especially by sharp tools such as Tweezers.
- Avoid leaving fingerprints on the quartz lens.
- Please store the LEDs away from dusty areas or seal the product against dust.
- When populating boards in SMT production, there are basically no restrictions regarding the form of the pick and place nozzle, except that mechanical pressure on the quartz lens must be prevented.
- Please do not mold over the quartz lens with another resin. (epoxy, urethane, etc)

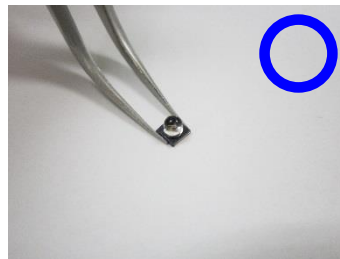
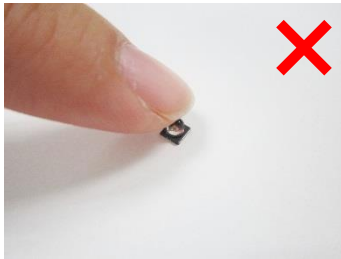

DISCLAIMER

- The information in this document has been compiled from reference materials and other sources believed to be reliable, and given in good faith. No warranty, either expressed or implied, is made, however, to the accuracy and completeness of the information, nor is any responsibility assumed or implied for any loss or damage resulting from inaccuracies or omissions. Each user bears full responsibility for making their own determination as to the suitability of Prolight products, recommendations or advice for its own particular use. Prolight makes no warranty or guarantee, express or implied, as to results obtained in end-use, nor of any design incorporating its Products, recommendation or advice.
- Each user must identify and perform all tests and analyses necessary to ensure that its finished application incorporating Prolight products will be safe and suitable for use under end-use conditions. Each user of devices assumes full responsibility to become educated in and to protect from harmful irradiation. Prolight specifically disclaims any and all liability for harm arising from buyer's use or misuse of UV devices either in development or end-use.